

# *the Quick Touch™ Crisp*

Quick Guide - BMO700/SMO700



# **Sage®**



## Contents

2	Sage recommends safety first	
13	Components	
14	Assembly	
16	Functions	
-	Setting the clock	16
-	Setting the beep volume	17
-	Setting the unit of weight	17
-	Setting child lock	18
-	Independent kitchen timer	18
-	Time & power level adjustment	18
-	When cooking is finished	21
-	Fan only	21
-	Stop/Clear	21
-	SMART SETTINGS	22
-	SMART COOK   GRILL	22
-	SMART REHEAT	32
-	SMART DEFROST	34
-	A Bit More™	37
-	FAVOURITE	38
-	GRILL ONLY	39
46	Care & Cleaning	
47	Troubleshooting	
47	Guarantee	

# SAGE RECOMMENDS SAFETY FIRST

**At Sage we are very safety conscious. We design and manufacture consumer products with the safety of you, our valued customer, foremost in mind. In addition we ask that you exercise a degree of care when using any electrical appliance and adhere to the following precautions.**

## IMPORTANT SAFEGUARDS

### READ ALL INSTRUCTIONS BEFORE USE AND SAVE FOR FUTURE REFERENCE

- Before using for the first time please ensure that your electricity supply is the same as shown on the rating label on the underside of the appliance. If you have any concerns please contact your local electricity company.
- Your Sage™ appliance includes a BS 13 amp moulded mains plug on the supply cord.

- Should you need to change this plug, please complete the rewiring as follows (after safe disposal of the moulded plug).
- Please note that a cut off plug inserted into a socket is a serious danger risk.
- Wires are coloured as follows:
  - Blue = Neutral
  - Brown = Live
  - Green & Yellow = Earth
- As the colours of the wire may not correspond with the coloured markings which identify the terminals in your plug, please refer to the following:
  - The Blue wire must be connected to the terminal which is marked 'N'.
  - The Brown wire must be connected to the terminal which is marked with the letter 'L'.
  - The Green & Yellow wire must be connected to the terminal which is marked with the letter E or the earth symbol  $\perp$ .
- Please note that if a 13 amp plug is used, a 13 amp fuse should be used.
- Remove and safely discard any packaging material and promotional labels before using the Sage microwave oven for the first time.
- To eliminate a choking hazard for young children, remove and safely discard the protective cover that is fitted to the power plug of the Sage microwave oven.
- Do not place the microwave oven near the edge of a bench or table during operation. Ensure all surfaces are level, clean and free of water or any other substances.
- Do not place the microwave oven on or near a hot gas or electric burner, or where it could touch a heated oven.
- Microwave oven to be installed as freestanding unit only.
- When using the microwave oven, provide adequate air space above and on all sides for air circulation. (see page 14 Installation, point 2).
- Always operate the microwave oven on a heat-resistant surface. Do not use on a cloth-covered surface, near curtains or other flammable materials.

- Do not use the microwave oven on a metal surface, for example a sink drain board.
- Always ensure the microwave oven is properly assembled before connecting to the power outlet and operating. Do not use the oven without the turntable roller and glass turntable in place. Ensure the glass turntable is positioned correctly into the indents on the turntable roller.
- The microwave oven is not intended to be operated by means of an external timer or separate remote control system.
- Never use the microwave oven without food or water in the oven cavity. Operating the microwave oven when empty could cause damage to the appliance.
- Do not leave the microwave oven unattended when in use.
- Do not touch hot surfaces. Allow the microwave oven to cool before moving or cleaning any parts.
- Do not place or store anything on top of the microwave oven.
- Always ensure the microwave oven is turned off at the power outlet and the cord is unplugged from the power outlet before attempting to move the appliance, when not in use, if left unattended and before disassembling, cleaning or storing.
- Keep the appliance clean. Follow the cleaning instructions provided in this book (page 46).
- Fire may occur if the oven is covered or touches flammable material, including curtains, draperies, walls and the like when in operation.
- Caution should be taken when toasting and grilling high oil content foods, such as pine nuts and walnuts. They may catch fire. If this occurs, please keep the oven door closed and switch off and unplug oven until flame has extinguished.
- Do not place cardboard, plastic, paper or other flammable materials into the oven.
- The temperature of accessible surfaces will be high when the appliance is in operation and also for some time after use.

- Always wear protective, insulated oven mitts when inserting, removing or handling items from the oven.
- Always use extreme caution when removing any of the accessories or disposing of hot grease. Allow the oven to cool before handling.
- Do not insert oversized foods into the oven as they create risk of fire or electric shock.
- It is recommended to use only the Sage provided accessories with this oven. Do not store any materials other than the Sage oven accessories in the oven when not in use.
- Do not clean interior of the oven with metal scouring pads as pieces can break off the pad and touch electrical parts creating a risk of electric shock.
- Do not attempt to operate the oven by any methods other than those described in this book.
- The top of the oven is very hot during and after operation. Do not store any item on top of the oven when in use and when stored.
- Do not touch hot surfaces. Appliance surfaces, including the door and outer surface of the oven are hot during and after operation. To prevent burns or personal injury, always use protective hot pads or insulated oven mitts, or use handles and knobs where available, when inserting, removing or handling items from the oven. Alternatively allow the oven to cool down before handling.
- The use of any accessory attachments not recommended by Sage may cause injuries.
- Use only the crisper pan provided by Sage. The crisper pan must always be placed at the centre of the glass turntable and make sure the crisper pan does not come in contact with the oven cavity which can cause electric shock
- Always turn the microwave oven off by pressing the STOP/ CLEAR button, switch off at the power outlet and unplug at the power outlet when it is not in use.
- Before cleaning, always press STOP/ CLEAR position, switch off at the power outlet and unplug at the power outlet.

# IMPORTANT SAFEGUARDS FOR ALL ELECTRICAL APPLIANCES



The symbol shown indicates that this appliance should not be disposed of in normal household waste. It should be taken to a local authority waste collection centre designated for this purpose or to a dealer providing this service. For more information, please contact your local council office.

- Fully unwind the power cord before use.
- Do not let the power cord hang over the edge of a bench or table, touch hot surfaces or become knotted.
- To protect against electric shock do not immerse the power cord, power plug or appliance in water or any other liquid.

- This appliance can be used by children aged from 8 years and above and persons with reduced physical, sensory or mental capabilities or lack of experience and knowledge if they have been given supervision or instruction concerning use of the appliance in a safe way and understand the hazards involved.
- Children should be supervised to ensure that they do not play with the appliance.
- Keep the appliance and its cord out of reach of children less than 8 years.
- Cleaning and user maintenance shall not be made by children without supervision unless they are aged from 8 years and above and supervised.
- Do not use the appliance if power cord, power plug or appliance becomes damaged in any way. If damaged or maintenance other than cleaning is required, please contact Sage Customer Service on 0808 178 1650 or go to [sageappliances.co.uk](http://sageappliances.co.uk).
- Any maintenance other than cleaning should be performed at an authorised Sage Customer Service.

- This appliance is for household use only. Do not use this appliance for anything other than its intended use. Do not use in moving vehicles or boats. Do not use outdoors. Misuse may cause injury.
- The installation of a residual current device (safety switch is recommended to provide additional safety protection when using electrical appliances. It is advisable that a safety switch with a rated residual operating current not exceeding 30mA be installed in the electrical circuit supplying the appliance. See your electrician for professional advice.
- Always turn the appliance to the OFF position, switch off at the power outlet and unplug at the power outlet when the appliance is not in use.
- Before cleaning, always turn the appliance to the OFF position, switch off at the power outlet, unplug at the power outlet and remove the power cord, if detachable, from the appliance and allow all parts to cool.
- Do not place this appliance on or near a heat source, such as hot plate, oven or heaters.
- Position the appliance at a minimum distance of 10 cm away from side walls and 20 cm from the top, curtains and other heat or stream sensitive materials and provide adequate space above and on all sides for air circulation.

### **SPECIAL SAFETY INSTRUCTIONS FOR YOUR MICROWAVE OVEN**

- Wipe the oven cavity with a soft, damp cloth after each use. Leaving food residue, grease or fat in the cavity could cause the microwave oven cavity to overheat and may cause the microwave oven to smoke or catch fire.
- The microwave oven should be cleaned regularly and any food splattering inside the cavity should be removed. Failure to maintain the microwave oven in a clean condition could lead to deterioration of the surface, adversely affecting the life of the microwave oven and possibly resulting in a hazardous situation.

- If the door seals or any of the microwave oven is damaged, the microwave oven must not be operated until it has been inspected and/or repaired at an authorised Sage Customer Service.
- The microwave oven is intended for heating food and beverages. Drying of food or clothing and heating or warming pads, slippers, sponges, damp cloth and similar may lead to risk of injury, ignition or fire.
- Ensure all food containers and/or plates are suitable for use in the microwave oven. This should be done prior to preparing food for heating or cooking in the microwave oven. Monitor foods and liquids heating or cooking in the microwave oven at all times due to the possibility of containers igniting.
- Containers or plates suitable for use in the microwave oven should not exceed the width of the glass turntable as this may impede the rotation of the turntable and result in food being unevenly cooked.
- Liquids or other foods must not be heated in sealed containers since they are liable to explode.
- Some containers and/or plates may appear suitable for use in the microwave oven but may be coated in a glaze that will absorb the microwave energy, overheat and cause the container to crack. The glaze may also prevent the food from heating/cooking.
- Food and/or liquids should not be heated or cooked directly on the glass turntable. Food and/or liquids must be placed into a suitable microwave-proof container before placing onto the glass turntable.
- Food and/or liquids should not be heated or cooked in plastic or paper containers or bags, unless specified a suitable for use by the manufacturer, due to the possibility of containers exploding or igniting.
- When heating food in plastic or paper containers, keep an eye on the oven due to the possibility of ignition.
- Metal clips or twist ties should be removed from the packaging as these could cause sparking and/or fire.



- Do not use recycled paper or kitchen paper towelling when cooking. Recycled paper may contain small metal or other impurities which could cause sparking and/or fire.
- Do not use metal containers or utensils in the microwave oven as these could cause sparking and/or fire unless supplied by Breville BMO700 microwave oven.
- Only use utensils that are suitable for use in microwave ovens.
- Food grade foil should not be used in the microwave oven as this could cause sparking and/or fire.
- Ensure that lids and caps covering containers are removed prior to placing liquids and/or foods into the microwave oven.
- Feeding bottles and baby food jars should have lids and caps removed before warming or heating in the microwave oven. To avoid burns or scalding after heating, the contents should be stirred or shaken and the temperature checked before serving.
- Always ensure the temperature of food or drink which has been heated or cooked in the microwave oven has been tested before eating, drinking or serving to others, especially children, disabled or elderly people.
- The heating of liquids and beverages in the microwave oven can result in delayed eruptive boiling. Care must be taken when handling any containers containing hot liquids or beverages.
- Do not heat popcorn in the microwave oven unless it has been commercially packaged for microwave use. There may be a number of un-popped kernels that may overcook and burn when popping popcorn. Do not use oil unless recommended by the manufacturer. Do not pop popcorn longer than the manufacturer's instructions (popping time should not exceed 3 minutes). Longer cooking could cause scorching or fire.

- Do not cook any food surrounded by a membrane (such as potatoes, chicken liver, egg yolks, oysters, etc) without first piercing the membrane several times with a fork or similar utensils.
- Eggs in the shell and whole hard boiled eggs should not be cooked or heated in the microwave oven as they may explode during cooking, at the end of cooking or after removing from the microwave oven.
- Do not heat oil or fat in the microwave oven. Doing so may cause the microwave oven and/or the oil to overheat and/or ignite.
- If any smoke is observed, switch off and unplug the microwave oven at the power outlet. Keep the door closed to stifle any flames.
- Do not attempt to operate the microwave oven by any method other than those described in this instruction book.
- Do not disconnect the microwave oven from the power supply by pulling on the cord to unplug from the power outlet.
- When storing the microwave oven loosely wind the cord. Do not wrap the cord around the microwave oven.
- When heating food in plastic or paper containers, keep an eye on the oven due to the possibility of ignition.
- The glass window has been specially treated to make it stronger, more durable and safer than ordinary glass, however it is not unbreakable. If dropped or struck extremely hard, it may break or weaken, and could at a later time shatter into many small pieces without apparent cause.



## WARNING

- Do not attempt to operate the oven with the door open since open-door operation can result in harmful exposure to microwave energy.
- It is important not to defeat or tamper with the safety interlocks.
- Do not place any object between the oven front face and the door or allow soil or cleaner residue to accumulate on sealing surfaces.
- Liquids and other foods must not be heated in sealed containers since they are liable to explode.
- If the door or door seals are damaged, the oven must not be operated until it has been repaired by a Sage Customer Service. It is particularly important that the oven door closes properly and that there is no damage to the:  
(1) Door (bent), (2) Hinges and latches (broken or loosened),  
(3) Door seals and sealing surfaces.
- Do not put any foreign material between the door and door jam of the microwave oven as this could cause excessive leakage of microwave energy.
- It is hazardous for anyone other than a Sage Customer Service to carry out any service or repair operation that involves the removal of a cover which gives protection against exposure to microwave energy.
- When the appliance is operated in the combination mode, children should only use the oven under adult supervision due to the temperature generated.
- Surfaces may be hot during and after use.
- If the apparatus is not maintained in a good state of cleanliness, its surface could be degraded and affect the lifespan of the product and lead to a dangerous situation.

## SPECIFICATIONS

---

**RATED POWER** 220-240V- 50Hz  
1800-1950W

---

**GRILL INPUT POWER** 840-1000W

---

**COMBINED INPUT POWER** 1800-1950W

---

**MICROWAVE INPUT POWER** 1450W

---

**MICROWAVE OUTPUT POWER** 900W 2450MHz

---

**OUTSIDE DIMENSIONS** 306mm (H)  
513mm (W)  
443mm (D) with handle  
397mm (D) without handle

---

**TURNTABLE DIAMETER** 315mm

---

**CRISPER PAN DIAMETER** 300mm

---

**NET WEIGHT** Approximately 15kg

---

**OVEN CAPACITY** 25 Litres

---

These specifications may change without notice.

**FOR HOUSEHOLD USE ONLY  
SAVE THESE INSTRUCTION**



## Components

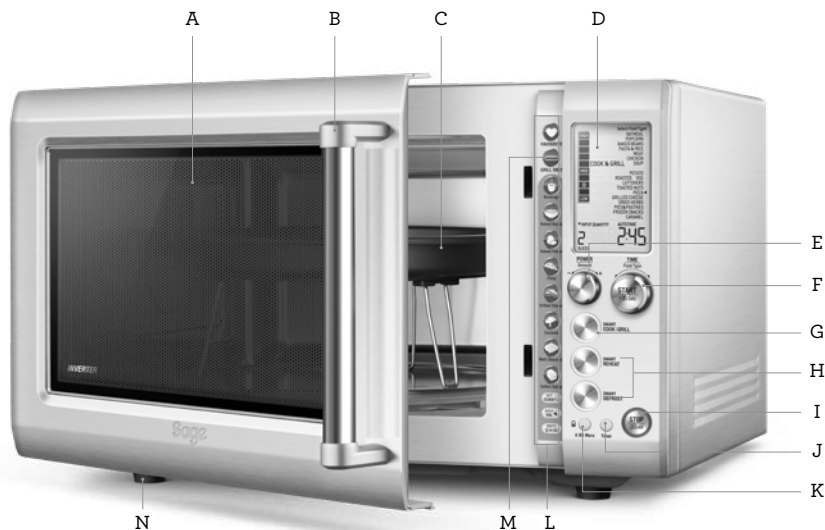

- A. Viewing window**
- B. Door handle**  
Pull handle to open.
- C. Crisper pan**
- D. LCD screen**
- E. POWER/AMOUNT dial**  
Turn dial to adjust the power level, weight & quantity that corresponds with the food type selected.
- F. +30 INSTANT START BUTTON & START/ FOOD TYPE/ TIME dial**  
Each press adds 30 second increments at 100% power. Turn dial to select food type or time.
- G. SMART COOK & GRILL BUTTON**  
Select from a range of food types with predetermined microwave and grill times.
- H. SMART REHEAT & DEFROST buttons**  
Allow you to choose from a range of common food types with predetermined
- times and power levels for selected weights.
- I. STOP/CLEAR button**  
Press once to pause without cancelling the program. Press twice to clear the display.
- J. TIMER button**  
A convenient kitchen timer that works independently. Easy to access and read while completing other kitchen tasks.
- K. A BIT MORE™ button & CHILD LOCK**  
Press once to add A BIT MORE™ time at the end of the cooking cycle. Press and hold for 3 seconds to set child lock.
- L. Shortcuts panel**  
Refer to operation section for detailed explanation.
- M. INDEPENDENT GRILL FUNCTION**  
1000 watt grill element can be used at anytime to brown and crisp food for added flavour and texture.
- N. Non-slip feet**

**CE UK CA** **Rating Information**  
220–240V ~ 50Hz 1800–1950W



## Assembly

### BEFORE FIRST USE

Before first use, remove all promotional stickers and packing material. Carefully unpack the microwave oven and keep all the packing material until all the parts of the microwave oven have been found and the appliance has been assembled. It is recommended to keep all the packing material in a safe place in case you wish to repack the product for shipping purposes.

To remove any dust that may have accumulated during packing, wash the turntable roller, glass turntable and crisper pan in warm soapy water, rinse in clean water then dry thoroughly. Wipe the interior and exterior of the microwave oven with a soft, damp cloth then dry thoroughly.

### ASSEMBLING THE GLASS TURNTABLE

1. Insert the turntable roller into position in the opening in the oven cavity base.
2. Place the glass turntable on top of the turntable roller, matching the indents of turntable roller at the centre area.

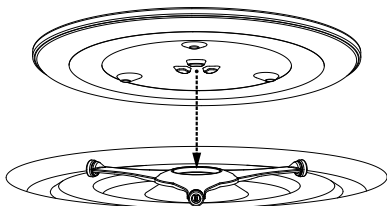
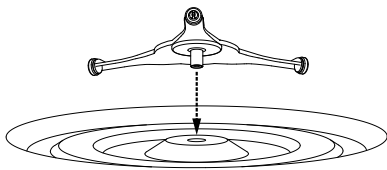

### INSTALLATION AND TURNING ON THE MICROWAVE OVEN

1. Select a level surface that provides enough open space for the intake and/or outlet vents. Blocking the intake and/or outlet openings can damage the microwave.
2. The rear surface of the appliance should be placed against a wall. A minimum clearance of 10cm is required between the microwave and any adjacent walls.
  - Leave a minimum clearance 20cm above the microwave.
  - Do not remove the legs from the bottom of the microwave.
3. Blocking the intake and/or outlet openings can damage the microwave.
4. Place the microwave as far away from radios and TV as possible.
5. Operation of microwave may cause interference to your radio or TV reception.
6. Plug the microwave into a standard household outlet. Be sure the voltage and the frequency is the same as the voltage and the frequency on the rating label.
7. The microwave must not be placed in a cabinet.

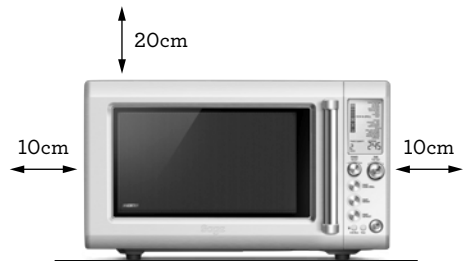

## USING THE CRISPER PAN

The crisper pan is ideal for crisping up items that can become soggy in the microwave, such as pizza, chicken nuggets and fries.

The crisper pan can be used in either the upper or lower position depending on the size of the food or how much browning is desired.

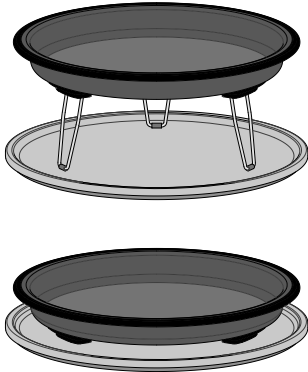

To reduce risk of injury, or damaging the microwave oven, ensure the crisper pan is placed securely in the centre of the turntable in both the upper and lower position.

Avoid placing Pyrex, plates or serving ware on the crisper pan as they may overheat and become damaged.

## CAUTION

The crisper pan surfaces and legs are hot during and after operation. This accessory is only to be used with the BMO700.

## WARNING

- To avoid an electrical circuit overload, it is recommended that no other appliances are plugged into the same circuit as your microwave oven (or other products) when it is in use.
- Do not install oven over a range cooktop or other heat-producing appliances. If installed near or over a heat source, the oven could be damaged and the warranty would be void.
- Check the oven for any damage, such as misaligned or bent door, damaged door seals and sealing surface, broken or loose door hinges and latches and dents inside the cavity or on the door. If there is any damage, do not operate the oven and contact a Sage service centre.
- Do not immerse the microwave oven, power cord or plug in water or any other liquid.



# Functions

## SETTING THE CLOCK

Press SET CLOCK  on the shortcuts panel. The default clock mode is 12hr. The selected mode will flash to show it can be adjusted.



Turn the TIME dial to change between 12hr and 24hr clock mode. Press START to confirm selection.



## Setting The Clock - 12 Hour Clock Display

The default time is 1:00AM. The hour digits will flash, indicating they can be changed.

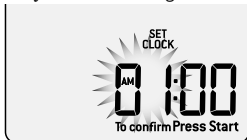

Turn the TIME dial to adjust the hour and AM/PM. Press START to confirm.



The minute digits will flash, indicating they can be changed. Turn the TIME dial to adjust the minutes and press START to confirm.



The standby screen is now the clock screen with the 12hr time.



## Setting The Clock - 24 Hour Clock Display

The default time is 1:00. The hour digits will flash, indicating they can be changed.



Turn the TIME dial to adjust the hour. Press START to confirm.



The minute digits will flash, indicating they can be changed. Turn the TIME dial to adjust the minutes and press START to confirm.





The standby screen is now the clock screen with the 24hr time.



### NOTE

To show the clock before standby mode is activated, press STOP/CLEAR.

### SETTING THE BEEP VOLUME

Press BEEP VOL on shortcuts panel.



The default beep volume is LOW.

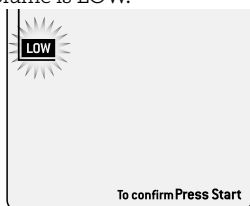
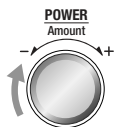

Turn POWER dial to toggle between LOW, MEDIUM and HIGH beep volume. Each position will sound the BEEP VOL selected. Press START button to confirm.

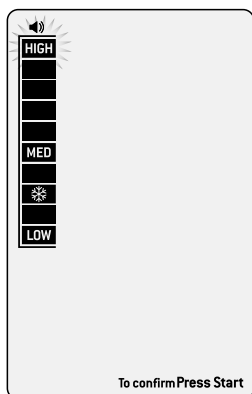

### NOTE

If you forget to press START to confirm BEEP VOL, the volume level will default to your selected setting after 1 minute.

### SETTING THE UNIT OF WEIGHT

Press UNITS on the shortcuts panel.



The highlighted ounces (oz) will flash to show it can be adjusted. Turn POWER dial to toggle between ounces (oz) and grams (g). Press START button to confirm.

### Unit Conversion During Operation

When weight is on the screen, as seen below in SMART REHEAT CHICKEN setting, pressing UNITS on shortcuts panel will convert the weight from grams (g) to ounces (oz).

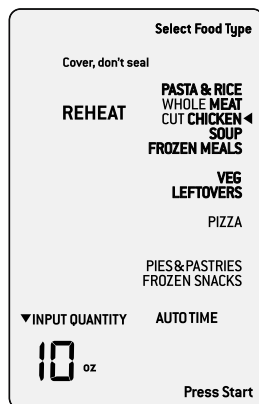
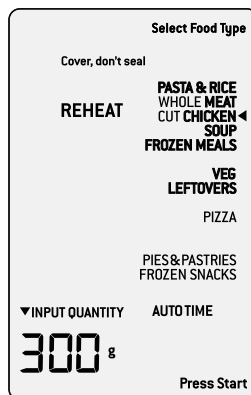

## SETTING CHILD LOCK

Press and hold the A Bit More™ button for 3 seconds. The CHILD LOCK symbol will display on the LCD screen, as well as the clock if it has been set.



**PRESS & HOLD  
FOR 3 SECONDS**

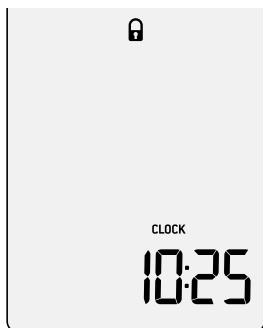

To unlock the microwave, press and hold the A Bit More™ button for 3 seconds.

The CHILD LOCK symbol will disappear from the LCD screen and the microwave will have full functionality.

## STANDBY

When the microwave has been idle for 1 minute, STANDBY mode will be activated. The backlight of the LCD will turn off and the buttons will no longer be illuminated.

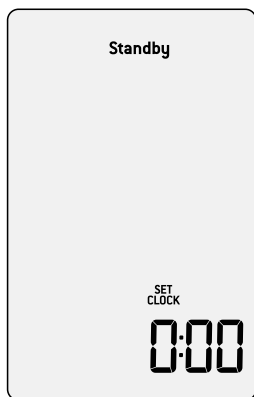

*Stand-by mode when the clock is not set.*

When the clock has been set STANDBY will not be displayed on the LCD screen.



*Stand-by mode when the clock is set.*

To 'wake up' the microwave press any button, turn any dial or open the door.

## INDEPENDENT KITCHEN TIMER

The independent kitchen timer can be used as either a count down or count up timer.

### Setting the count down timer

Press Timer on the control panel.  Timer

The default time is 00:00.



The highlighted digits flash to show it can be adjusted. Turn START dial to adjust to your desired time in seconds, minutes and hours. Press START button to begin.

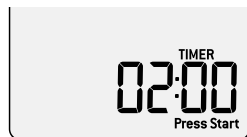

The timer begins to count down. To pause the timer, press STOP/CLEAR button once.

To clear the timer and return to the default screen press STOP/CLEAR button twice.



At the end of the timer function, the microwave will beep 3 times and 'End' will flash on the screen.



At the end of the 95 minutes, the microwave will beep 3 times and the word "End" will flash on the screen.



### Setting the count up timer

Press **TIMER** on the control panel. The default time is 00:00.



The second digits will flash to show it can be adjusted. Press **START** button to begin.



The maximum count up time is 95:00 (95 minutes).

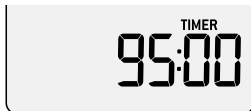

The timer begins to count up to 95 minutes. To pause the timer, press **STOP/CLEAR** button once. Press **START** to resume timer. To clear the timer and return to the default screen press **STOP/CLEAR** button twice.

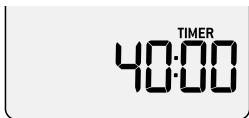

### NOTE

End will stay on screen for 1 minute before returning to the default screen.

### TIME & POWER LEVEL ADJUSTMENT

Select different times and microwave power levels by simply turning the **TIME** and **POWER** dials.

The maximum microwave cooking time is 95 minutes (95:00). There are 10 power levels available.

### Turning the TIME Dial

Turn **TIME** dial to adjust the time. The default time will be 30 seconds.

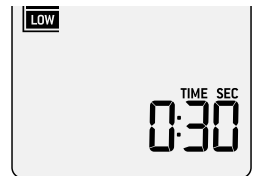
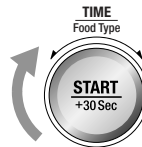

## Turning the POWER Dial

Turn the POWER dial clockwise. When the POWER dial is turned clockwise HIGH will flash and 100% will be displayed.

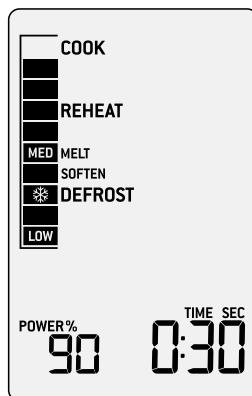
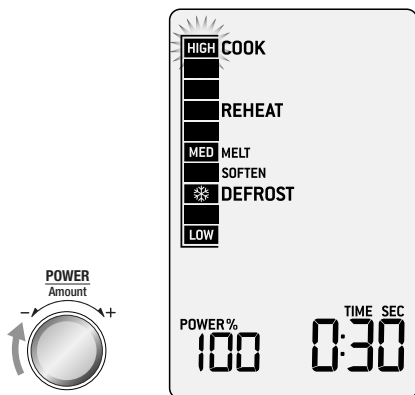

When the POWER dial is turned clockwise or anti-clockwise both MELT and SOFTEN will show on the LCD for 2 seconds then disappear.

When the POWER dial is turned anti-clockwise the POWER LEVEL% will start to decrease from 100% to 10%, in 10% increments.

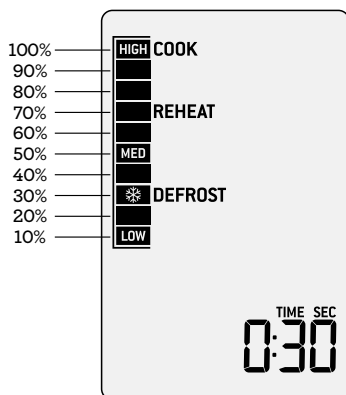

## MANUAL POWER & TIME ADJUSTMENT (SMART SETTINGS & SHORTCUT SETTINGS)

Smart Settings and Shortcut settings have pre-determined cook times and power levels to give the best results. However, to suit your personal preference adjustment of both power and time is available during the cooking cycle. Adjusting the power level while heating does not affect the time.

The power bar will reflect the cooking power level including programs where variable power levels are used.

It is completely normal in these programs to see the power bar change during the cooking cycle.

### +30 SEC INSTANT START

Press START/+30 Sec to begin cooking instantly for 30 seconds with 100% microwave power. Each additional press will increase the cooking time by 30 seconds.

## WHEN COOKING IS FINISHED

At the end of any cooking cycle, the microwave will beep 3 times, and the word End will flash on screen.

The word End will stay flashing on the screen for 1 minute or once the door is opened.

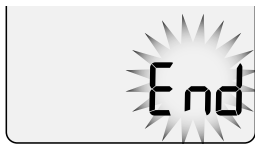

## FAN ONLY

At the end of the cooking cycle, the fan may rotate to cool the electric components. This is perfectly normal. You are still able to remove your food from the microwave while the fan operates.

The microwave (heating) icon will no longer be displayed and the words FAN ONLY will flash on the screen.

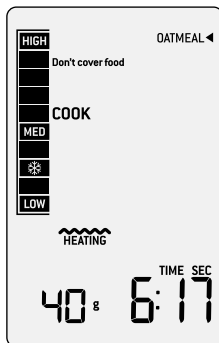

Heating



Cooling Fan

## STOP/CLEAR

Press STOP/CLEAR once to pause the current function. Press twice to clear and return to the default screen.

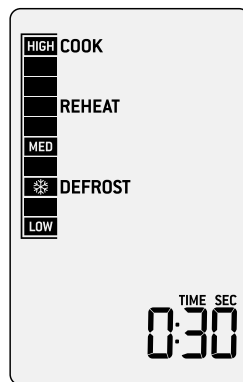

When in the default screen, press once to show the clock.

The clock will only show if it is set. To set the clock, follow the instructions on page 16.

To return to the default screen press any button, turn any dial or open the door.

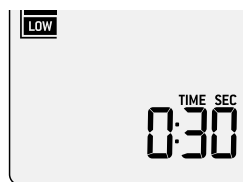

## SMART SETTINGS

Choose from SMART COOK | GRILL, SMART REHEAT and SMART DEFROST.

Then select from a list of commonly used food types and press START. The microwave will automatically set the power level, microwave time and grill time for the selected quantity.

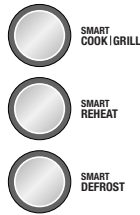

## SMART COOK | GRILL

The SMART COOK|GRILL setting uses predetermined microwave and grill times to take the guess work out of cooking your favourite food. It has been optimized to work in conjunction with the crisper pan and is ideal for crisping up items that can become soggy from microwave heating.

Press SMART COOK|GRILL button to enter SMART COOK|GRILL settings, the microwave will beep once.

Turn TIME/FOOD TYPE dial to select food type.

As the TIME/FOOD TYPE dial is turned the arrow shifts and points to what food type is selected.

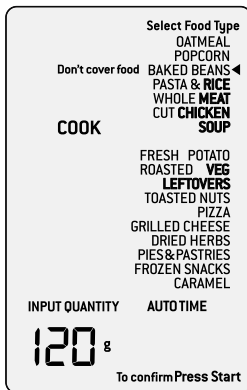
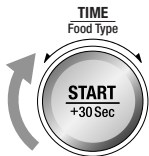

## Selecting a COOK setting

After selecting FOOD TYPE, turn AMOUNT dial to adjust quantity or weight.

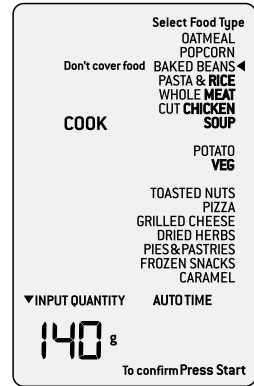
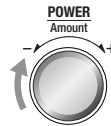

Press START to begin cooking.

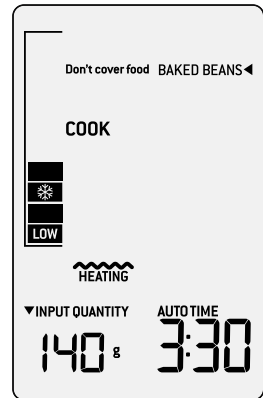

All unselected FOOD TYPES, the Press Start and Input Quantity prompts are no longer displayed on the LCD screen. The TIME appears and begins to countdown.

## NOTE

While the microwave is heating time can be increased or decreased. Adjusting the heating time does not affect selected weight or quantity.

## Selecting a COOK & GRILL setting

Turn TIME/FOOD TYPE dial to select COOK & GRILL food type.

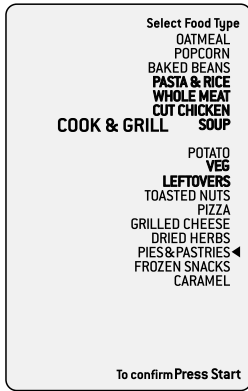

Press START to display FROZEN or FRESH options. Turn TIME/FOOD TYPE dial to shift the arrow. Press START to confirm your selection.

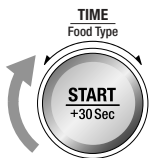

Once FROZEN or FRESH has been selected the PREHEAT PAN option will appear.

Turn the TIME/FOOD dial to toggle between yes or no. Press START to confirm your selection.

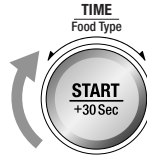

## NOTE

For best results, it is recommended to preheat the crisper pan.

### Preheating the crisper pan

Although the pan pre-heating time is locked to total of 3 minutes, it can be reduced by turning the dial anti-clock wise.

After selecting PREHEAT PAN the microwave will prompt you to insert the empty crisper pan. The time will display as 3 minutes, it can be reduced by turning the dial anti-clock wise.

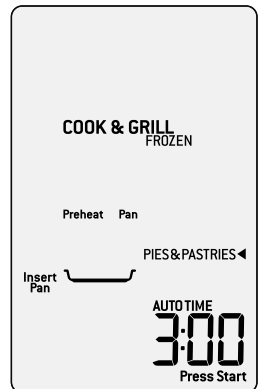

Insert the tray in the upper position and press **START** to begin preheating. **TIME** will begin to countdown.

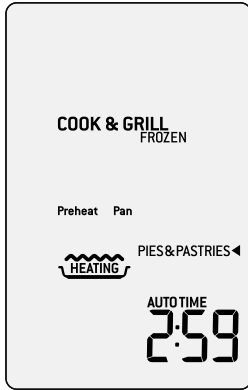
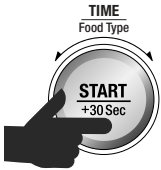

**NOTE**

The preheat pan time has been determined through kitchen testing to offer the best food results. To reduce risk of injury, or damaging the microwave oven, the preheat time has been locked to 3 minutes.

Once the pan has completed preheating, or if preheating phase is skipped, the microwave will prompt you to place food on pan.

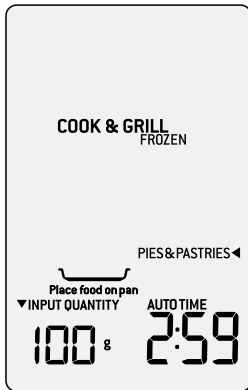

Turn **AMOUNT** dial to adjust quantity or weight.

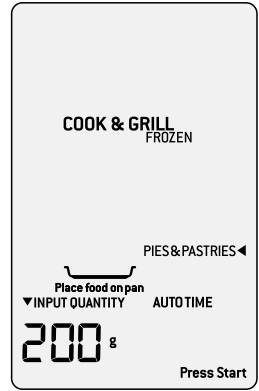

Press **START** to begin cooking. All unselected **FOOD TYPES**, the **Press Start** and **Input Quantity** prompts are no longer displayed on the LCD screen. The **TIME** appears and begins to countdown.

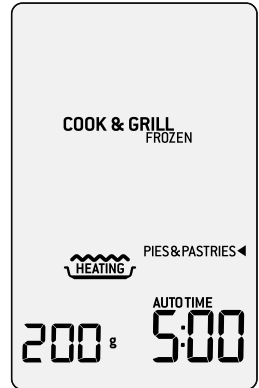
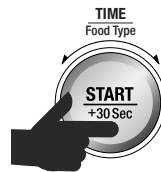



Microwave, grill or combination icons will display as the cooking cycle progresses.

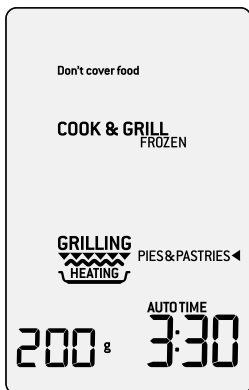
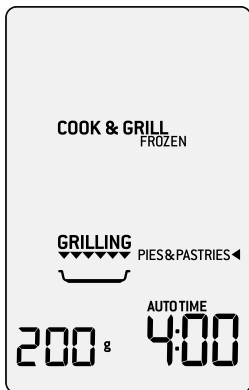

#### Icon descriptions

 = Microwave only

  
 = Grill only

 = Microwave + grill

## FOR BEST RESULTS

### Oatmeal

The SMART COOK OATS setting designed to gently cook your oats to tender without drying or becoming lumpy.

The setting uses 2 power levels, firstly 100% to get the starches activated and then 50% to gently cook to tender.

This setting is suitable for quick cook rolled oats.

Weigh out oats accurately and place into a deep microwave-safe bowl. Do not cover the bowl.

Add corresponding water amount. E.g. if you are cooking 100g of oats you will need 500ml water. For creamy oats, use 1 part oats to 5 parts water.

See Oats table on this page.

Turn the AMOUNT dial to select weight and press START to begin cooking.

Halfway through the cook program, the oven will beep and will flash “stir/turn food”. Pause and stir oats and press START to continue.

At the end of the cooking cycle, stand for 5 minutes to allow oats to thicken and set. Stir through milk, yoghurt or cream.

OATS	WATER	SERVES
40g (½ cup)	200ml	1-2
60g (¾ cup)	300ml	2-3
120g (1 cup)	600ml	3-4
180g (1½ cups)	900ml	4-5
240g (2 cups)	1.2L	5-6

### Popcorn

The SMART COOK POPCORN setting is designed to pop the maximum amount of kernels in each bag.

Turn the AMOUNT dial to select weight and press START to begin cooking.

Pre-set weights are based on the following popcorn bag sizes.

## Rice

The SMART COOK RICE setting is designed to cook rice so the rice grains remain separate and tender.

The rice program is intelligently programmed to cook your rice on 2 power levels, firstly at 100% and then at 50%.

The rice setting is suitable for white rice such as long grain rice, arborio, jasmine and basmati.

Weigh dry rice accurately and wash well with cold water until water runs clear. Place into a microwave-safe bowl.

Add corresponding water amount. Water to rice ratio is based on 1.5 parts water to 1 part rice. See Rice table on this page.

Cover bowl with a vented microwave-safe plastic lid or vented microwave-safe plastic wrap but do not seal.

Turn the AMOUNT dial to select weight and press START to begin cooking.

At the end of the cooking cycle, stand for 5 minutes before removing the lid. Stir and serve.

RICE	WATER	SERVES
200g	300ml	1-2
250g	375ml	2
300g	450ml	2-3
350g	525ml	3-4
400g	600ml	4-5
450g	675ml	5-6
500g	750ml	6-7
600g	900ml	7-8

## Meat

The SMART COOK MEAT setting is suitable for cooking lamb cutlets, chops and T-bone steaks.

Cook times are based on meat directly from the refrigerator (approx. 5°C)

Preheat the crisper pan in the upper position by following the prompts in the SMART COOK MEAT setting.

Once the pan has completed preheating, carefully remove the hot crisper pan from the microwave using ovenproof mitts.

Arrange meat on the pan making sure thicker ends are positioned towards the outer edges of the crisper pan. Place crisper pan in the centre of the turntable in the upper position.

Turn the AMOUNT dial to select weight and press START to begin cooking.

Halfway through the cook program, the oven will beep and will flash "stir/turn food". Pause and carefully pull out the crisper pan. Turn meat over, return crisper pan to the microwave and press START to continue.

At the end of the cooking cycle, allow meat to stand for 5 minutes in the crisper pan before removing and serving.

## Chicken

The SMART COOK CHICKEN setting is suitable for cooking chicken pieces such as mini drumsticks, wings, thighs and breast.

Cook times are based on chicken directly from the refrigerator (approx. 5°C)

Preheat the crisper pan in the upper position by following the prompts in the SMART COOK CHICKEN setting.

Once the pan has completed preheating, carefully remove the hot crisper pan from the microwave using ovenproof mitts.

Arrange chicken pieces on the pan making sure thicker ends are positioned towards the outer edges of the crisper pan. Place crisper pan in the centre of the turntable in the upper position.

Turn the AMOUNT dial to select weight and press START to begin cooking.

Halfway through the cook program, the oven will beep and will flash “stir/turn food”. Pause and carefully pull out the crisper pan. Turn chicken pieces over, return crisper pan to the microwave and press START to continue.

At the end of the cooking cycle, allow chicken to stand for 5 minutes in the crisper pan before removing and serving.

## Soup

The SMART COOK SOUP setting is designed to cook 2 different soup recipes.

Select from 500ml, 1L and 2L of cooked soup and follow ingredient weights and cook times.

Cut vegetables into very small diced pieces approximately ½ cm in size.

Place butter and chopped onion into a deep microwave-safe bowl. See Pumpkin Soup and Potato & Leek Soup tables below for cooking method and weights.

Cover bowl with a vented microwave-safe plastic lid or vented microwave-safe plastic wrap but do not seal.

Turn the AMOUNT dial to select weight and press START to begin cooking.

During the cook program, the microwave will beep and will flash “stir/turn food”. Pause and add remaining ingredients. Reseal and press START to continue.

At the end of the cooking cycle, allow soup to stand for 5 minutes before removing the lid.

Carefully remove the lid and puree with a stick blender until smooth.

Season to taste with salt and pepper. Serve with a dash of cream or milk (optional).

## Pumpkin Soup Table

Recipe conversion to different sizes

AMOUNT	BUTTER	PEELED & FINELY CHOPPED ONION	PEELED & FINELY DICED POTATO	PEELED & FINELY DICED PUMPKIN	CHICKEN STOCK	SERVES
500ml	20g	75g	125g	125g	250ml	1-2
1L	50g	150g	250g	250g	500ml	4-5
2L	80g	300g	500g	500g	1L	6-8

## Potato & Leek Soup Table

Recipe conversion to different sizes

AMOUNT	BUTTER	WASHED & FINELY CHOPPED LEEK	PEELED & FINELY DICED POTATO	CHICKEN STOCK	SERVES
500ml	20g	200g	125g	250ml	1-2
1L	40g	400g	250g	500ml	4-5
2L	80g	800g	500g	1L	7-8

### **Potato - Cut**

The SMART COOK CUT POTATO setting is suitable for all types of potatoes.

Cook times are based on potatoes at room temperature (approx. 20°C).

Peel and cut potatoes into 30-40g size pieces and place in a microwave-safe bowl.

Add 1 tablespoon of water per 100g of potato.

Cover bowl with a vented microwave-safe plastic lid or vented microwave-safe plastic wrap but do not seal.

Turn the AMOUNT dial to select weight and press START to begin cooking.

Halfway through the cook program, the oven will beep and will flash "stir/turn food".

Pause and stir potatoes, reseal and press START to continue.

At the end of the cooking cycle, allow potatoes to stand for 5 minutes before serving.

### **Potato - Whole**

The SMART COOK WHOLE POTATO setting is suitable for large whole Sebago or unwashed potatoes approx. 300-400g in weight.

Cook times are based on potatoes at room temperature (approx. 20°C).

Wash potatoes to remove dirt and residue from the surface. Pat dry and prick 4-5 times with a fork.

Arrange potatoes around the outer edges of the crisper pan. Place crisper pan in the centre of the turntable in the lower position.

Turn the AMOUNT dial to select number of potatoes and press START to begin cooking.

Halfway through the cook program, the oven will beep and will flash "stir/turn food".

Pause and carefully pull out the crisper pan.

Turn potatoes, return crisper pan to the microwave and press START to continue.

At the end of the cooking cycle, allow potatoes to stand for 5 minutes in the crisper pan before removing and serving.

### **Veg - Fresh**

The SMART COOK FRESH VEG setting is suitable for all types of vegetables such as carrots, beans, broccoli, cauliflower and zucchini.

Cook times are based on vegetables directly from the refrigerator (approx. 5°C)

Cut vegetables into even sized pieces and place in a microwave-safe bowl. Add 1 tablespoon of water per 100g of vegetables.

Cover bowl with a vented microwave-safe plastic lid or vented microwave-safe plastic wrap but do not seal.

Turn the AMOUNT dial to select weight and press START to begin cooking.

Halfway through the cook program, the oven will beep and will flash "stir/turn food".

Pause and stir vegetables, reseal and press START to continue.

At the end of the cooking cycle, allow vegetables to stand for 5 minutes before serving.

### **Veg - Frozen**

The SMART COOK FROZEN VEG setting is suitable for all types of packaged frozen vegetables found at your supermarket such as carrots, beans, broccoli, cauliflower and zucchini.

Cook times are based on vegetables from the freezer (approx. -18°C)

Place vegetables in a microwave-safe bowl. Cover bowl with a vented microwave-safe plastic lid or vented microwave-safe plastic wrap but do not seal.

Turn the AMOUNT dial to select weight and press START to begin cooking.

Halfway through the cook program, the oven will beep and will flash "stir/turn food".

Pause and stir vegetables, reseal and press START to continue.

At the end of the cooking cycle, allow vegetables to stand for 5 minutes before serving.

## **Veg - Roasted**

The SMART COOK ROASTED VEG setting is suitable for small chat potatoes, pumpkin, sweet potato and onion.

Cook times are based on vegetables at room temperature (approx. 20°C).

Preheat the crisper pan in the upper position by following the prompts in the SMART COOK ROASTED VEG setting.

Once the pan has completed preheating, carefully remove the hot crisper pan from the microwave using ovenproof mitts.

Cut vegetables into 3-5cm even sized pieces and toss in olive oil. Arrange vegetables on the pan making sure thicker ends are positioned towards the outer edges of the crisper pan. Place crisper pan in the centre of the turntable in the upper position

Turn the AMOUNT dial to select weight and press START to begin cooking.

Halfway through the cook program, the oven will beep and will flash "stir/turn food". Pause and carefully pull out the crisper pan. Turn vegetables over, return crisper pan to the microwave and press START to continue.

At the end of the cooking cycle, allow vegetables to stand for 5 minutes in the crisper pan before removing and serving.

## **Toasted Nuts**

The SMART COOK TOASTED NUTS setting is suitable for toasting whole nuts such as walnuts, cashews, raw and blanched almonds, macadamia nuts and pine nuts so they are golden in colour and crisp in texture.

Weigh nuts and place onto the crisper pan in a single layer. Place crisper pan in the centre of the turntable in the lower position.

Turn the AMOUNT dial to select weight and press START to begin cooking.

Halfway through the cook program, the oven will beep and will flash "stir/turn food". Pause and carefully pull out the crisper pan. Stir nuts, return crisper pan to the microwave and press START to continue.

At the end of the cooking cycle, if nuts are to your desired colour and crispness, remove to a cold plate.

If nuts require more heating, allow nuts to stand for 5-10 minutes in the crisper pan, stirring once or twice during this time.

## **Pizza - Fresh**

The SMART COOK FRESH PIZZA setting is ideal for reheating any cold leftover cooked pizza so the dough is crisp and the toppings hot and melted.

Cook times are based on pizza directly from the fridge (approx. 5°C).

Preheat the crisper pan in the upper position by following the prompts in the SMART COOK FRESH PIZZA setting.

Once the pan has completed preheating, carefully remove the hot crisper pan from the microwave using ovenproof mitts.

Arrange pizza slices on the pan making sure thicker ends are positioned towards the outer edges of the crisper pan. Place crisper pan in the centre of the turntable in the upper position.

Turn the AMOUNT dial to select number of slices and press START to begin cooking.

Halfway through the cook program, the oven will beep and will flash "stir/turn food". Pause and carefully pull out the crisper pan. Rearrange food so that the food in the centre of the pan is moved to the outside and vice versa. Return crisper pan to the microwave and press START to continue.

At the end of the cooking cycle, allow pizza slices to stand for 5 minutes in the crisper pan before removing and serving.

## **Pizza - Frozen**

The SMART COOK FROZEN PIZZA setting is ideal for reheating frozen pizza so the dough is crisp and the toppings hot and melted.

Cook times are based on pizza directly from the freezer (approx. -18°C).

Preheat the crisper pan in the upper position by following the prompts in the SMART COOK FROZEN PIZZA setting.

Once the pan has completed preheating, carefully remove the hot crisper pan from the microwave using ovenproof mitts.

Arrange pizza slices on the pan making sure thicker ends are positioned towards the outer edges of the crisper pan. Place crisper pan in the centre of the turntable in the upper position.

Turn the AMOUNT dial to select number of slices and press START to begin cooking.

Halfway through the cook program, the oven will beep and will flash “stir/turn food”. Pause and carefully pull out the crisper pan. Re-arrange food so that the food in the centre of the pan is moved to the outside and vice versa. Return crisper pan to the microwave and press START to continue.

At the end of the cooking cycle, allow pizza slices to stand for 5 minutes in the crisper pan before removing and serving.

## **Dried - Herbs**

The SMART COOK DRIED HERBS setting heats fresh herbs so they become dry and crisp in texture. It is a great way to use up an abundance of fresh herbs in your garden as they will retain good colour and fragrance for longer than store bought varieties.

For best results use hard herbs such as thyme, rosemary, sage, oregano and even continental parsley.

Pick leaves off the fresh herbs and discard the stalk or stem. Wash gently in a sieve to remove any grit and dirt. Shake to remove excess water and pat dry with a paper towel.

Line crisper pan with 2 layers of paper towel, measure herbs and place onto the crisper pan in a single layer. Place crisper pan in the centre of the turntable in the lower position.

Turn the AMOUNT dial to select cup size and press START to begin cooking.

Halfway through the cook program, the oven will beep and will flash “stir/turn food”. Pause and carefully pull out the crisper pan. Turn herbs, return crisper pan to the microwave and press START to continue.

At the end of the cooking cycle, if herbs are to your desired crispness, remove to a cold plate.

If herbs require more heating, remove paper towel and allow herbs to stand for 5-10 minutes in the crisper pan, stirring once or twice during this time.

Store your dried herbs in an airtight container in a dark cupboard for 6-12 months.

## **Pies & Pastries - Frozen**

The SMART COOK FROZEN PIES & PASTRIES setting is ideal for reheating any frozen cooked, savoury or sweet pie or pastry so the filling is hot and the outside crisp and golden. It is suitable for foods such as meat pies, apple pies, party pies, sausage rolls, danishes and crumbles.

Cook times are based on pies and pastries directly from the freezer (approx. -18°C).

Preheat the crisper pan in the upper position by following the prompts in the SMART COOK FROZEN PIES & PASTRIES setting.

Once the pan has completed preheating, carefully remove the hot crisper pan from the microwave using ovenproof mitts.

Arrange pies or pastries on the pan allowing 1-2 cm gaps between the pieces in the crisper pan. Place crisper pan in the centre of the turntable in the upper position.

Turn the AMOUNT dial to select weight and press START to begin cooking.

Halfway through the cook program, the oven will beep and will flash “stir/turn food”. Pause and carefully pull out the crisper pan. Re-arrange food so that the food in the centre of the pan is moved to the outside and vice versa. Return crisper pan to the microwave and press START to continue.

At the end of the cooking cycle, allow pies and pastries to stand for 5 minutes in the crisper pan before removing and serving.

### **Pies & Pastries - Fresh**

The SMART COOK FRESH PIES & PASTRIES setting is ideal for reheating any fresh cooked savoury or sweet pie or pastry so the filling is hot and the outside crisp and golden. It is suitable for foods such as meat pies, apple pies, party pies, sausage rolls, danishes and crumbles.

Cook times are based on pies and pastries directly from the fridge (approx. 5°C)

Preheat the crisper pan in the upper position by following the prompts in the SMART COOK PIES & PASTRIES setting.

Once the pan has completed preheating, carefully remove the hot crisper pan from the microwave using ovenproof mitts.

Arrange pies or pastries on the pan allowing 1-2 cm gaps between the pieces in the crisper pan. Place crisper pan in the centre of the turntable in the upper position.

Turn the AMOUNT dial to select weight and press START to begin cooking.

Halfway through the cook program, the oven will beep and will flash “stir/turn food”. Pause and carefully pull out the crisper pan. Re-arrange food so that the food in the centre of the pan is moved to the outside and vice versa. Return crisper pan to the microwave and press START to continue.

At the end of the cooking cycle, allow pies and pastries to stand for 5 minutes in the crisper pan before removing and serving.

### **Frozen Snacks**

The SMART COOK FROZEN SNACKS setting is ideal for reheating frozen snacks such as chicken nuggets, fish fingers, breaded chicken strips, frozen crumbed fish fillets and frozen potato chips.

Cook times are based on food snacks directly from the freezer (approx. -18°C)

Preheat the crisper pan in the upper position by following the prompts in the SMART COOK FROZEN SNACKS setting.

Once the pan has completed preheating, carefully remove the hot crisper pan from the microwave using ovenproof mitts.

Arrange food pieces on the pan making sure thicker ends are positioned towards the outer edges of the crisper pan. Place crisper pan in the centre of the turntable in the upper position.

Turn the AMOUNT dial to select weight and press START to begin cooking.

Halfway through the cook program, the oven will beep and will flash “stir/turn food”. Pause and carefully pull out the crisper pan. Turn food over, return crisper pan to the microwave and press START to continue.

At the end of the cooking cycle, allow food to stand for 5 minutes in the crisper pan before removing and serving.

## SMART REHEAT

The SMART REHEAT setting uses lower power levels to gently reheat food without overcooking or drying it out.

SMART REHEAT setting will heat your food to perfect serving temperatures.

Press SMART REHEAT button to enter SMART REHEAT settings, the microwave will beep once.



Turn TIME/FOOD TYPE dial to select food type.

As the TIME/FOOD TYPE dial is turned the arrow shifts and points to what food type is selected.

After selecting FOOD TYPE, turn AMOUNT dial to adjust quantity or weight.

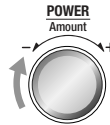
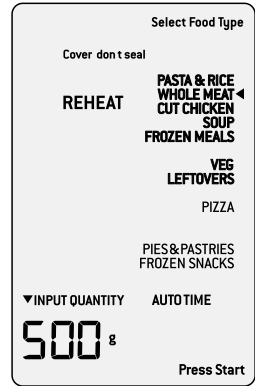

Press START to begin reheating.

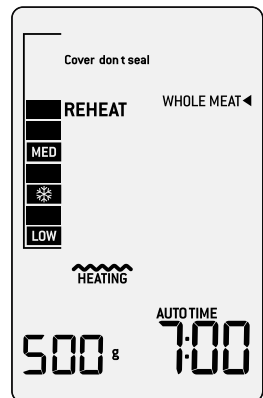
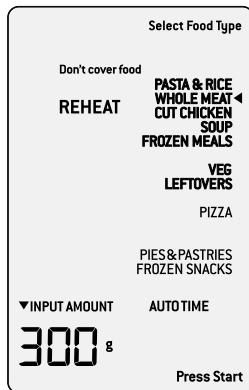
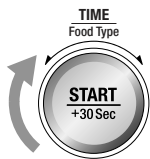

All unselected FOOD TYPES, the Press Start and Input Quantity prompts are no longer displayed on the LCD screen. The TIME appears and begins to countdown.



## NOTE

While the microwave is heating, time can be increased or decreased. Adjusting the heating time does not affect selected weight or quantity.



## FOR BEST RESULTS

### Pasta & Rice

The SMART REHEAT PASTA & RICE setting is suitable for reheating already cooked pasta and rice.

Reheat times are based on rice and pasta directly from the refrigerator (approx. 5°C).

Place food in a microwave-safe bowl. Add a few tablespoons of water or sauce.

Cover bowl with a vented microwave-safe plastic lid or vented microwave-safe plastic wrap but do not seal.

Halfway through the reheat program, the oven will beep and will flash “stir/turn food”.

Pause and stir food, starting from the outside of the bowl to the centre. Reseal and press START to continue.

### Meat

The SMART REHEAT MEAT setting is suitable for reheating already cooked chops, steaks and bolognese. Reheat times are based on meat directly from the refrigerator (approx. 5°C).

Arrange meat on the pan making sure thicker ends are positioned towards the outer edges of the crisper pan. Place crisper pan in the centre of the turntable in the upper position.

If reheating bolognese, place in a microwave-safe container and do not cover.

Halfway through the reheat program, the oven will beep and will flash “stir/turn food”.

Pause and turn and press START to continue.

### Chicken

The SMART REHEAT CHICKEN setting is designed to gently reheat chicken pieces without drying and overcooking. It is not suitable for reheating whole chickens.

Reheat times are based on chicken pieces directly from the refrigerator (approx. 5°C).

Arrange chicken pieces on the pan making sure thicker ends are positioned towards the

outer edges of the crisper pan. Place crisper pan in the centre of the turntable in the upper position.

Halfway through the reheat program, the oven will beep and will flash “stir/turn food”

Pause and carefully pull out the crisper pan. Turn chicken pieces over, return crisper pan to the microwave and press START to continue.

For larger amounts over 1kg, turn chicken twice during the cooking cycle.

### Soup

The SMART REHEAT SOUP setting is suitable for reheating canned soups at room temperature 20°C.

Place soup into a microwave-safe bowl and cover with a vented microwave-safe lid or microwave-safe plastic wrap.

Halfway through the reheat program, the oven will beep and will flash “stir/turn food”

Pause and stir, starting from the outside to the centre.

Reseal and press START to continue.

When reheating cold soups from the refrigerator (approx. 5°C) add an extra 1-2 minutes to the reheat time.

### Frozen Meals

The SMART REHEAT FROZEN MEALS setting is suitable for reheating homemade or store bought frozen casseroles, curries and frozen dinners to serving temperatures.

Reheat times are based on frozen meals directly from the freezer (approx. -18°C)

Remove frozen meal from packaging and place in a microwave-safe container or plate.

Cover container with a vented microwave-safe plastic lid or vented microwave-safe plastic wrap but do not seal.

Halfway through the reheat program, the oven will beep and will flash “stir/turn food”. Pause and stir food, starting from the outside of the container to the centre. Carefully break up any large parts of thawed meat and stir or turn over. Reseal and press START to continue.

## Veg

The SMART REHEAT VEG setting is suitable for reheating already cooked cold vegetables such as potatoes, peas, beans, broccoli, cauliflower and zucchini.

Reheat times are based on vegetables from the refrigerator (approx. 5°C).

Place vegetables in a microwave-safe bowl and cover with a vented microwave-safe plastic lid or vented microwave-safe plastic wrap but do not seal.

Halfway through the reheat program, the oven will beep and will flash “stir/turn food”. Pause and stir vegetables, reseal and press START to continue.

## Leftovers

The SMART REHEAT LEFTOVERS setting is suitable for reheating a plate of leftovers from the refrigerator (approx. 5°C).

A plate of food is equivalent to 300g.

For even reheating, place food onto a microwave-safe plate or into a bowl. Cover food with a vented microwave-safe lid or vented microwave-safe plastic wrap.

Halfway through the reheat program, the oven will beep and will flash “stir/turn food”.

Pause and stir, reseal and press START.

## SMART DEFROST

The SMART DEFROST setting is designed to gently defrost foods without overheating it or drying out the edges.

Press the SMART DEFROST button. The microwave will beep once.



Turn TIME/FOOD TYPE dial to select the food type.

As the TIME/FOOD TYPE dial is turned the arrow shifts and points to what food type is selected.

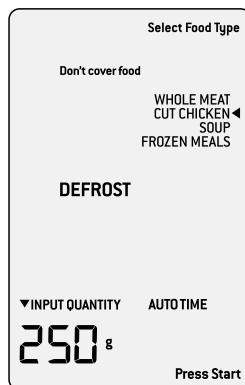

After selecting FOOD TYPE, turn AMOUNT dial to adjust quantity or weight.

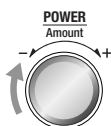

Press **START** to begin the defrost cycle.

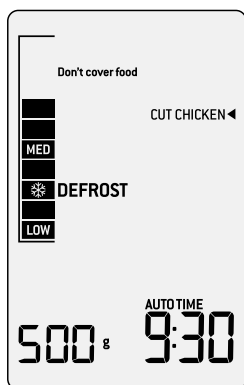

All unselected **FOOD TYPES**, the Press Start and Input Quantity prompts are no longer displayed on the LCD screen. The **TIME** appears and begins to countdown.



## NOTE

While the microwave is defrosting time can be increased or decreased. Adjusting the defrosting time does not affect selected weight or quantity.

## FOR BEST RESULTS

- Defrost times are for thoroughly frozen food that has been in the freezer for at least 24 hours and maintained at temperatures of  $-18^{\circ}\text{C}$  or lower.
- When freezing meats, poultry and fish, use good quality plastic wrap, bags and containers.
- Always freeze meats in a single layer no thicker than 3-5 cm.
- To separate meat, such as chicken pieces or steak, place wax paper or plastic film between each layer.

- Ensure that all air has been removed and packaging has been sealed securely.
- Label the packs with type and cut of meat, date and weight.
- Remove any packaging and bags from frozen meats before defrosting.
- Shield thin ends of chops, steaks or chicken with foil to prevent overheating and cooking of those areas.
- Position foods in a single layer with thinner parts in the centre and thicker ends around the outside of the turntable.
- After the defrost cycle, most foods will still be somewhat icy in the centre when removed from the microwave. Stand food for 5-15 minutes until completely thawed.

## Meat

The **SMART DEFROST MEAT** setting is suitable for defrosting meat such as beef, lamb and pork.

It is important that the frozen meat is no thicker than 3-5 cm.

Remove any packaging, foam trays and absorbent pads from the meat.

Place directly onto a microwave-safe plate or shallow dish.

Halfway through the defrost program, the oven will beep and will flash "stir/turn food"

Pause and remove any defrosted meat and set aside in the refrigerator. Turn the frozen meat over and return to the microwave oven. Press **START** to restart program.

At the end of the program, remove meat and stand 5-15 minutes to thaw completely.

## Chicken

For chicken pieces; position chicken pieces in a single layer in a microwave-safe dish, plate or container.

Arrange thicker ends around the outside of the turntable. Shield thinner pieces such as wings with foil to prevent overheating and cooking.

Halfway through the defrost program, the oven will beep and will flash “stir/turn food”.

Pause and turn over chicken pieces. Press START to restart program.

At the end of the cooking cycle, remove chicken from oven and stand 5-15 minutes to thaw completely.

### For whole chickens

Remove from original packaging. Rinse frozen chicken under cold water and pat dry. Shield wings, leg tips and parson's nose with foil.

Place chicken, breast side down onto the turntable lined with a paper towel.

Halfway through the defrost program, the oven will beep and will flash “stir/turn food”

Pause and turn chicken over. Place a strip of foil large enough to cover the breast meat. Press START to restart defrost program.

After defrost cycle has ended, remove chicken from microwave and discard foil. Rinse under tap water, making sure to wash the cavity well to loosen the icy core.

Place onto a clean plate and pat dry.

Cover with cling film and refrigerate until completely thawed.

## Soup

The SMART DEFROST SOUP setting is suitable for defrosting frozen homemade or store bought soups directly from the freezer (approx.  $-18^{\circ}\text{C}$ ).

Remove soup from any packaging and place into a microwave-safe bowl. Do not cover.

Halfway through the defrost program, the oven will beep and will flash “stir/turn food”

Pause and break up any large icy parts of the soup by stirring from the outside of the bowl to the centre. Press START to continue.

After the defrost cycle has ended, the soup will be ready for reheating to serving temperatures. Choose a suitable setting from the SMART REHEAT menu.

### Frozen meals

The SMART DEFROST FROZEN MEALS setting is suitable for defrosting homemade frozen casseroles, curries and meat sauces.

Defrost times are based on frozen meals directly from the freezer (approx.  $-18^{\circ}\text{C}$ )

Remove frozen meal from any packaging and place into a microwave-safe container.

Do not cover.

Halfway through the reheat program, the oven will beep and will flash “stir/turn food”.

Pause and stir food from the outside towards the centre; press START to continue.

For meals which contain large pieces of meat such as chicken pieces, carefully break up any thawed parts and stir or turn meat over.

After the defrost cycle has ended, the food will be ready for reheating to serving temperatures. Choose a suitable setting from the SMART REHEAT menu.

## A BIT MORE™ BUTTON

Use A BIT MORE™ when cooking is finished and your food is not quite cooked or hot enough.



One simple press of A BIT MORE™ will add a little extra cooking time.

If A BIT MORE™ is pressed and there is no previous SMART COOK & GRILL, REHEAT, DEFROST or shortcut setting the microwave will default to the basic mode and add extra time at 100% power.

The A BIT MORE™ button can also be used after any SMART COOK & GRILL, REHEAT, SMART DEFROST or shortcut setting.

### For example

1. User presses the SMART REHEAT button.



2. Using the TIME/FOOD TYPE dial, select MEAT.

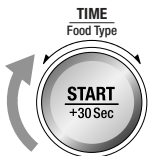

3. Using the AMOUNT dial select 200g.

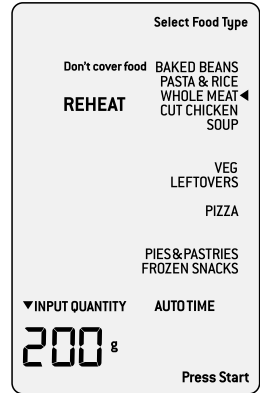
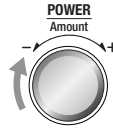

4. Press START to begin reheating.

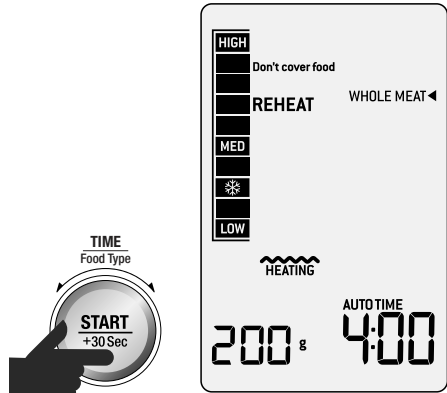

5. Reheat process ends.



- Open the Microwave door, check food, and if A BIT MORE™ reheating time is required, close the door. The microwave will return to the default screen.

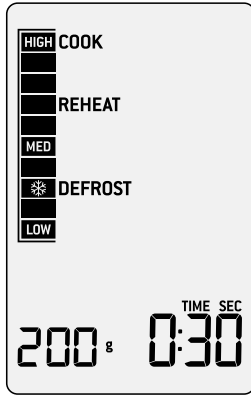

- Press the A BIT MORE™ button to add A BIT MORE™ cooking time. The timer will start to count down.

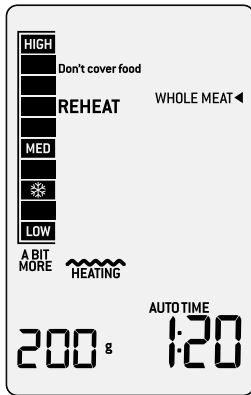

### NOTE

As soon as A BIT MORE™ button is pressed the microwave will start cooking.

### FAVOURITE

The shortcuts FAVOURITE setting will record your most used and favourite reheat, defrost or shortcut setting.

At the press of a button, your favourite program can be duplicated time after time.

- Set the microwave to your favourite setting.
- Press and hold the FAVOURITE  button on shortcuts panel inside the door for 2 seconds. The FAVOURITE symbol will be displayed on the LCD screen.
- Press START to begin your favourite setting.

### NOTE

The microwave will save this setting for future use. Pressing the Favourite button next time will display your saved Favourite setting on the LCD screen. To change your FAVOURITE setting at any time, repeat steps 1 and 2 above.

## GRILL ONLY

The shortcuts GRILL ONLY setting is ideal for adding extra colour to already cooked foods such as melts, pies, pastries and snack foods.

1. Press the GRILL ONLY  button on the shortcuts panel inside the door.
2. Preheat the crisper pan in the upper position by following the prompts in the GRILL ONLY setting.
3. Once the pan has completed preheating, carefully remove the hot crisper pan from the microwave using ovenproof mitts.
4. Arrange food on the pan making sure thicker ends are positioned towards the outer edges of the crisper pan. Place crisper pan in the centre of the turntable in the upper position.
5. Turn the TIME dial to the grill time and press START to begin cooking.

## Beverage

The shortcuts BEVERAGE setting is suitable to reheat hot drinks such as coffee and tea that may have become cold. The BEVERAGE setting will warm your drink to approx. 60–65°C which is suitable to drink right away.

1. It is based on 200ml of beverage at room temperature.
2. Position cups around the outside of the turntable.
3. Press the BEVERAGE  button on the shortcuts panel inside the door.
4. Turn the AMOUNT dial to select the number of cups and press START to begin cooking.
5. At the end of the reheat cycle, stir heated drinks and allow to stand for 1–2 minutes before consuming. Be aware, that overheating drinks may scold or burn.

## Baked beans

The shortcuts BAKED BEANS setting is programmed to reheat baked beans to serving temperatures without splattering and breaking up of the beans.

1. Place beans into a suitable microwave-safe bowl and do not cover.
2. Press the BAKED BEANS  button on shortcuts panel inside the door.
3. Turn AMOUNT DIAL to select weight and press START button to begin heating.

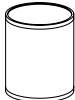
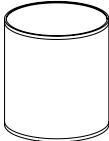
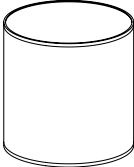
COMMON CAN SIZES	COMMON CAN WEIGHT	SELECTED WEIGHT ON MICROWAVE
	120g-130g	120g
	220g	220g
	420g-425g	425g
	820g-850g	850g

## Baked Potato

The shortcuts BAKED POTATO setting is suitable for large whole Sebago or unwashed potatoes approx. 300-400g in weight.

Cook times are based on potatoes at room temperature (approx. 20°C).

1. Wash potatoes to remove dirt and residue from the surface. Pat dry and prick 4-5 times with a fork.
2. Arrange potatoes around the outer edges of the crisper pan. Place crisper pan in the centre of the turntable in the lower position.
3. Press the BAKED POTATO  button on the shortcuts panel inside the door.
4. Turn the AMOUNT dial to select the number of potatoes and press START to begin cooking.
5. Halfway through the cook program, the oven will beep and will flash "stir/turn food". Pause and carefully pull out the crisper pan. Turn potatoes, return crisper pan to the microwave and press START to continue.
6. At the end of the cooking cycle, allow potatoes to stand for 5 minutes in the crisper pan before removing and serving.



## Pizza

The shortcuts PIZZA setting reheats frozen pizza so the dough is crisp and the toppings hot and melted.

Cook times are based on pizza directly from the freezer (approx. -18°C).

1. Press the PIZZA  button on the shortcuts panel inside the door.
2. Preheat the crisper pan in the upper position by following the prompts in the PIZZA setting.
3. Once the pan has completed preheating, carefully remove the hot crisper pan from the microwave using ovenproof mitts.
4. Arrange pizza slices on the pan making sure thicker ends are positioned towards the outer edges of the crisper pan. Place crisper pan in the centre of the turntable in the upper position.
5. Turn the AMOUNT dial to select weight and press START to begin cooking.
6. Halfway through the cook program, the oven will beep and will flash “stir/turn food”. Pause and carefully pull out the crisper pan. Re-arrange food so that the food in the centre of the pan is moved to the outside and vice versa. Return crisper pan to the microwave and press START to continue.
7. At the end of the cooking cycle, allow pizza slices to stand for 5 minutes in the crisper pan before removing and serving.

## Grilled Cheese

The shortcuts GRILLED CHEESE setting makes either closed toastie sandwiches or open melts so the cheese is melted and the bread is crisp and golden.

This setting is suitable for any type of bread such as sliced white bread or thick, grained sourdough. For best results, liberally apply butter or your spread of choice to at least one side of the bread.

1. Press the GRILLED CHEESE  button on the shortcuts panel inside the door.
2. Preheat the crisper pan in the upper position by following the prompts in the GRILLED CHEESE setting.
3. Once the pan has completed preheating, carefully remove the hot crisper pan from the microwave using ovenproof mitts.
4. When making closed toasties; butter outside of bread slices and fill with cheese (and cold cuts if desired) ensuring toastie filling is no thicker than 1cm. Arrange toasties on the pan. Place crisper pan in the centre of the turntable in the upper position.
5. When making open melts; arrange buttered bread slices on the crisper pan without any toppings. Place crisper pan in the centre of the turntable in the upper position.
6. Turn the AMOUNT dial to select number of serves and press START to begin cooking.
7. Halfway through the cook program, the oven will beep and will flash “stir/turn food”. Pause and carefully pull out the crisper pan.  
**For closed toasties;** turn toasties over, return crisper pan to the microwave and press START to continue.  
**For open toasties;** turn bread slices over, add cheese and toppings and return crisper pan to the microwave. Press START to continue.
8. At the end of the cooking cycle, remove and serve immediately.

## Caramel

The shortcuts CAMEL setting is ideal for making sauces or hard toffee.

The CAMEL setting uses 2 power levels, firstly 80% to dissolve the sugar in the water and then 100% to evaporate the water and melt the sugar.

This setting is suitable for making light caramel. To increase the darkness see darkness table below for additional times.

1. Choose a clear Pyrex bowl that is large enough to contain the hot sugar mixture when boiling. Wash the bowl well to remove any residue oil or grit that will cause the caramel to crystallise.
2. Place sugar and water into the bowl and mix well with a metal spoon. See Caramel table below for cooking method and weights.
3. Wash down any stray sugar grains from the side of the bowl using a pastry brush dipped in clean water. Stray sugar grains will cause the caramel to crystallise if not properly incorporated.
4. Place the bowl in the centre of the turntable.
5. Press the CAMEL  button on the shortcuts panel inside the door.
6. Turn the AMOUNT dial to select weight and press START to begin cooking.
7. During the cook program, the oven will beep and will flash "stir/turn food". Pause and carefully remove the cooking bowl from the microwave using oven proof mitts.



### CAUTION

Melted sugar is extremely hot and will burn if it comes into contact with the skin.

Always practice extreme caution when cooking caramel.

8. Swirl the bowl gently to dissolve any remaining sugar. Wash down any stray sugar grains from the side of the bowl using a pastry brush dipped in clean water.
9. Return bowl to the microwave and press START to continue.
10. At the end of the cooking cycle, if caramel is to your desired colour, carefully remove the cooking bowl from the microwave using oven proof mitts.
11. To make toffee; pour hot sugar mixture onto a metal tray lined with baking paper. Add any additional ingredients and leave at room temperature to cool completely.
12. To make butterscotch sauce; add butter and cream to the hot sugar mixture and stir through.
13. If caramel is not to your desired colour, add additional time following the darkness table below and check every 30 seconds. Always remove caramel when it is close to your desired colour as it will continue to cook after heating has stopped and become darker on standing.

## Caramel Table

Recipe conversion to different sizes

AMOUNT	SUGAR	WATER	CHECK EVERY 1 MIN AFTER
1 cup	1 cup (220g)	½ cup (125ml)	10 mins
2 cups	2 cups (440g)	1 cup (250ml)	20 mins

## Darkness Table

CAMEL COLOUR	TIME ADDED AFTER COOKING	CHECK EVERY
Light	1-3 min	30 sec
Medium	2-4 min	30 sec
Dark	3-4 min	30 sec

## Melt chocolate

The shortcuts MELT CHOCOLATE setting is designed to melt chocolate without overheating and seizing of the chocolate.

### NOTE

The melt chocolate setting was tested with dark chocolate melts. If using other types of chocolate, check at short intervals to prevent possible seizing of chocolate.

1. Place chocolate in a suitable microwave-safe bowl and do not cover.
2. Press the MELT CHOCOLATE  button on shortcuts panel inside the door.
3. Turn AMOUNT DIAL to select weight and press START button to commence melting.
4. Halfway through the program, the microwave will beep and will flash. Stir/turn food. Pause and stir chocolate and press START button to continue.

### NOTE

At the end, some of the chocolate may still hold their shape; stir until completely melted and smooth.

## Soften butter

The shortcuts SOFTEN BUTTER setting is designed to soften butter so it is suitable to cream immediately in a mixer.

The soften butter setting will soften butter that has been taken directly from the refrigerator (approx. 5°C).

1. Cut butter as a whole piece and place on a microwave-safe plate or bowl. Do not cover.
2. Press the SOFTEN BUTTER  button on shortcuts panel inside the door.
3. Turn AMOUNT DIAL to select weight and press START button to commence softening.

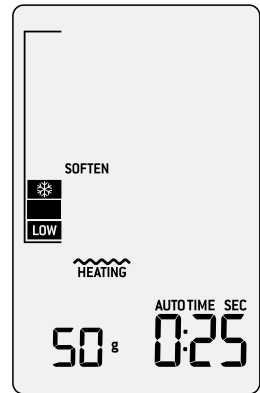

### NOTE

The butter should be soft enough to poke your finger easily into the centre. The butter should not be melted.

## INTRODUCTION TO MICROWAVE COOKING

- Microwaves are invisible waves of electromagnetic energy similar to radio waves. Instead of being converted to sound as in a radio or mobile phones, it is converted into a heat source which heats food from the inside.
- Microwaves cook because food molecules of water, fat and sugar react to the energy provided by the microwaves. That energy is absorbed by the food causing the molecules to vibrate quickly. This movement creates friction which causes the food to heat up and therefore cook.
- The energy in a microwave is not distributed evenly throughout the cavity. The turntable rotates constantly while cooking which prevents uneven cooking.
- Microwave cooking is considered the “cool” cooking method as only the food gets hot and surrounding air stays cool.
- Microwaves are safe and economical on electricity with savings up to 50%.
- Ovens need no preheating therefore the kitchen stays cooler. Cooking is cleaner with less odours and washing up is reduced.
- Microwave ovens cook foods rapidly, some foods are better cooked in a microwave oven as they retain more flavor, texture and goodness, such as plain fish fillets, soft fruit, vegetables and fat free cakes.
- In a microwave the heat is produced **INSIDE** the food. In all other conventional cooking methods, heat is applied from **OUTSIDE** through transference of heat by convection or radiation.
- Microwave energy penetrates the food to a depth of about 25mm. Small foods under 5cm in diameter such as eggs are penetrated to the centre from all sides. In larger foods, energy creates heat in the outer layer; this then moves to the centre by conduction, as it does with conventional cooking.

## SOME IMPORTANT TIPS FOR MICROWAVE COOKING

To help equalize energy in the food so that it cooks evenly follow these helpful tips.

1. Arrange foods with varying size ends, such as chicken drumsticks and broccoli with the thicker or tougher part positioned to the outside of the dish. This ensures the parts that require more cooking will receive more energy, so the food will cook evenly.
2. Covering the dish during cooking holds in the heat and steam to speed up cooking time. Use a microwave safe lid or plastic wrap that has been vented by turning back one edge at the side of the dish to form a narrow vent to release excess steam.
3. Choose cooking dishes that are shallow and preferably have straight sides. Shallow dishes enable the food to cook faster and straight edges prevent the edges from being overcooked.
4. Arrange individual items such as ramekins or whole potatoes around the outside of the turntable. Make sure to leave space between items so the energy can penetrate from all sides.
5. Use round shaped microwave dishes. Round shapes cook more evenly than square or rectangle dishes which absorb most of the energy in the corners causing food to overcook and toughen.
6. Heat breads, biscuits or oily food on the crisper pan or paper towel. This prevents the build up of steam between food and glass turntable, keeping surfaces crisp and dry. Cover foods with paper towel to prevent splatters.
7. Stir foods from the outside to centre of the dish once or twice during cooking to equalize heat and speed microwaving.
8. Turn medium to large food items over twice during microwaving. This enables even exposure to microwaves.

9. Elevating some types of food such as cakes, roast vegetables and dough products can be advantageous. It allows more energy to penetrate the food from all sides, base and top. Use a microwave safe plastic or ceramic rack. If a rack is unavailable, use an upturned bowl or cup to elevate plates of food.
10. Do not elevate any special browning dishes, jugs of sauce or custard, small quantities of food or mugs of beverages.
11. Internal temperatures of foods continue to rise so that they continue cooking even after they have been removed from the microwave oven. It is better to under cook food as it will continue to cook once removed from the microwave.

## **MICROWAVE UTENSILS**

- Containers, plates, dishes, etc. used in the microwave oven should always be microwave-safe. Check if stated on the underside of the utensil or contact the manufacturer.
- To test if a container, plate or dish is microwave-safe, place it into the microwave oven with 1 cup of cold water (in a microwave-safe cup) and heat on High (100%) Power for 1 minute. If the container is hot and the water is cold, the container is not suitable for microwave oven use. If the container is cold and the water is hot, then the container is suitable for microwave oven use.
- Microwave-safe cookware will not become hot by the microwave energy, but it will become hot from contact with hot food. When the food becomes hot, some of this heat is transferred to the dish. Always use oven mitts or clothes to remove hot dishes from the microwave.
- Metal containers and utensils should not be used in the microwave oven unless provided with BMO700 microwave oven.



## Care & Cleaning

- Switch off the microwave oven at the power outlet and remove the plug from the power outlet before cleaning.
- Keep the inside of the microwave oven clean. When food splatters or spilled liquids adhere to the microwave oven internal walls, wipe with a damp cloth. Mild detergent may be used if the cavity gets very dirty. Avoid the use of spray and other harsh cleaners as they may stain, streak or dull the door surface.
- The outside surfaces should be cleaned with a damp cloth. To prevent damage to the operating parts inside the microwave oven cavity, water should not be allowed to seep into the ventilation openings.
- Wipe the door and window on both sides of the door seals and adjacent parts frequently with a damp cloth to remove any spills or spatters. Do not use an abrasive cleaner.
- Do not allow the control panel to become wet. Clean with a soft, damp cloth. When cleaning the control panel, leave the microwave oven door open to prevent it from accidentally turning on.
- If steam accumulates inside or around the outside of the oven door, wipe with a soft dry cloth. This may occur when cooking foods high in moisture or if the microwave oven is operated under high humidity conditions, this is normal.
- It is occasionally necessary to remove the glass turntable for cleaning. Wash the glass turntable in warm soapy water, rinse in clean water and dry thoroughly.
- The turntable roller and microwave oven floor should be cleaned regularly to ensure the glass turntable rotates correctly and avoids making excessive noise. Simply wipe the bottom surface of the microwave with a soft damp cloth. The turntable roller may be washed in mild soapy water, rinse in clean water and dry thoroughly. When removing

the turntable roller from the cavity floor for cleaning, be sure to replace in the proper position.

- Remove odours from your microwave oven by combining a cup of water with the juice of one lemon in a deep microwave-safe bowl, microwave on High for 5 minutes. Wipe the microwave oven cavity thoroughly and dry with a soft cloth.
- When it becomes necessary to replace the oven light, please consult Sage Service Centre to have it replaced.
- Please do not dispose this appliance with domestic rubbish; it should be taken to the appropriate disposal centre provided by the local council municipalities.
- If storing the microwave oven, press the STOP/CLEAR button, switch off at the power outlet then unplug the power cord. Ensure the microwave oven is completely cool, clean and dry. Secure the roller ring and glass turntable and close the door. Do not place heavy objects on top. Store the microwave oven upright.

### BEFORE YOU CALL FOR SERVICE

- Check to ensure that the oven is plugged in securely. If it is not, remove the plug from the power outlet, wait 10 seconds and plug it in again securely.
- Check for a blown circuit fuse or a tripped main circuit breaker. If these seem to be operating properly, test the power outlet with another appliance.
- Check to ensure that the control panel is programmed correctly and the timer is set.
- Check to ensure that the door is securely closed engaging the door safety lock system. Otherwise, the door safety lock system will prevent the microwave from switching on.



### NOTE

If none of the above rectify the situation, then contact your Sage Service Centre. Do not try to adjust or repair the oven yourself.



# Troubleshooting

POSSIBLE PROBLEM	EASY SOLUTION
Microwave oven interfering with radio, TV or similar equipment.	<ul style="list-style-type: none"> <li>• Clean door and sealing surface of the oven.</li> <li>• Reorient the receiving antenna of radio or television.</li> <li>• Relocate the microwave oven with respect to the receiver.</li> <li>• Move the microwave oven away from the receiver.</li> <li>• Plug the microwave oven into a different outlet so that microwave oven and receiver are on different branch circuits.</li> </ul>
Dim microwave oven light.	<ul style="list-style-type: none"> <li>• When operating on low power levels, the microwave oven light may be dimmer.</li> </ul>
Steam accumulating on door and hot air coming out from vents.	<ul style="list-style-type: none"> <li>• During operation, steam may be produced. Most will exit through the vents, however some may accumulate around the oven door.</li> </ul>
Microwave oven will not start.	<ul style="list-style-type: none"> <li>• Power cord not plugged in properly or switched on.</li> <li>• Fuse blown or circuit breaker problem.</li> <li>• Trouble with outlet.</li> <li>• Unplug, put the plug in again and switch on.</li> <li>• Replace the fuse or reset circuit breaker.</li> <li>• Have a professional check that the outlet is not faulty.</li> </ul>
Microwave oven does not heat.	<ul style="list-style-type: none"> <li>• Door not closed properly.</li> <li>• Ensure door is shut properly.</li> </ul>
Glass turntable makes noise during operation.	<ul style="list-style-type: none"> <li>• Turntable roller not assembled properly or needs to be cleaned.</li> <li>• Reset and clean if necessary.</li> </ul>
LCD time digit shows EA1A then V1:00 or similar information then goes to default mode.	<ul style="list-style-type: none"> <li>• Both A BIT MORE™ &amp; SMART REHEAT button are pressed at the same time under the default mode.</li> <li>• No action required. This is normal and LCD just shows the model type and software version.</li> </ul>
LCD time digit shows 00 for a short period of time then shows 1 or 0 and stays at 1 or 0.	<ul style="list-style-type: none"> <li>• Both A BIT MORE™ &amp; SMART REHEAT button are pressed at the same time under the default mode.</li> <li>• If the LCD time digit stays at 0, send the unit back to repair.</li> <li>• If LCD time digit stays at 1, Press STOP/CLEAR to set the unit back to default mode.</li> </ul>



## Guarantee

### 12 MONTH LIMITED GUARANTEE

Sage Appliances guarantees this product for domestic use in specified territories for 12 months from the date of purchase against defects caused by faulty workmanship and materials. During this guarantee period Sage Appliances will repair, replace, or refund any defective product (at the sole discretion of Sage Appliances).

All legal warranty rights under applicable national legislation will be respected and will not be impaired by our guarantee. For full terms and conditions on the guarantee, as well as instructions on how to make a claim, please visit [www.sageappliances.com](http://www.sageappliances.com).

GBR

BRG Appliances Limited  
Unit 3.2, Power Road Studios,  
114 Power Road, London, W4 5PY  
Freephone (UK Landline): 0808 178 1650  
Mobile Calls (National Rate): 0333 0142 970

IRE

Ireland  
1800 932 369

ESP

Spain  
9000 838 534

ITL

Italy  
800 909 773

POR

Portugal  
8000 180 243

DEU

AUT

Sage Appliances GmbH  
Campus Fichtenhain 48, 47807 Krefeld,  
Deutschland

Deutschland: 0800 505 3104  
Österreich: 0800 80 2551

BEL

Belgium  
8000 54 155

NO

Norway  
80 024 976

NLD

Netherlands  
8000 020 1741

SE

Sweden  
0200 123 797

FRA

Sage Appliances France SAS  
Siège social: 66 avenue des Champs  
Elysées – 75008 Paris  
879 449 866 RCS Paris  
France: 0800 903 235

LUX

Luxembourg  
8000 880 72

DK

Denmark  
080 820 827

CHE

Switzerland  
8000 009 933

FI

Finland  
8000 412 143

# Sage®

[www.sageappliances.com](http://www.sageappliances.com)

Registered in England & Wales No. 8223512  
Registered in Germany No. HRB 81309 (AG Düsseldorf)  
Registered in France No. 879 449 866 RCS

EN Due to continued product improvement, the products illustrated or photographed in this document may vary slightly from the actual product.

DEU Aufgrund unserer kontinuierlichen Produktverbesserungen kann die hier gezeigte Abbildung geringfügig vom tatsächlichen Produkt abweichen.

FRA En raison de leur amélioration continue, les produits représentés ou photographiés dans le présent document peuvent différer légèrement du produit réel.

ITL A causa del continuo miglioramento dei prodotti, il prodotto descritto o illustrato in questo documento può variare leggermente rispetto al prodotto reale.

NLD Vanwege voortdurende productverbeteringen, kunnen de afgebeelde producten in dit document licht afwijken van het eigenlijke product.

ESP Perfeccionamos nuestros productos continuamente, por lo que el artículo podría diferir ligeramente de la ilustración o la fotografía en este documento.

POR Devido à melhoria continua dos produtos, os produtos ilustrados ou fotografados neste documento podem variar ligeiramente do produto real.

DK På grund af løbende produktudvikling kan de illustrerede eller fotograferede produkter i dette dokument variere en smule fra det faktiske produkt.

SE På grund av kontinuerlig produktförbättring kan produkterna som visas i illustrationerna och fotografierna i detta dokument skilja sig något från den faktiska produkten.

FI Jatkuvan tuotekehittelyn seurauksena kuvituksen tuotteet eivät välttämättä ole täysin samanlaisia kuin varsinainen tuote.

NO På grunn av kontinuerlig produktutvikling kan produktene som er vist eller avfotografert i dette dokumentet, variere noe fra det faktiske produktet.

Copyright BRG Appliances 2021

BMO700/SMO700 UG1 E21